

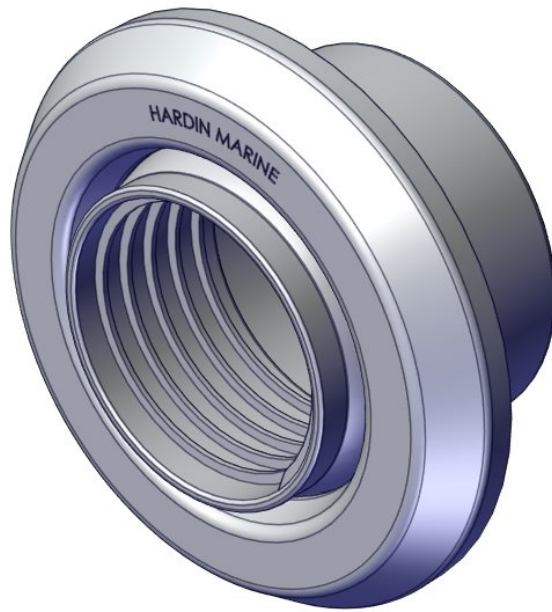

SWIVEL RIGGING HOSE KIT

755-1000, 755-1001, 755-1002
& 755-1003



SWIVEL RIGGING HOSE KIT

HARDIN 11 Industry Dr. Palm Coast, FL 32137
MARINE 386-445-2500 / FAX 386-445-1122

PART NO.
620-336180

www.hardin-marine.com

TITLE:

RIGGING THRU HULL - DRILL TEMPLATE

INSTRUCTIONS:

- 1) MAKE SURE PRINTER IS SET AT 100%.
- 2) POSITION THE THRU HULL AHEAD OF THE ENGINE SO THAT IT ALLOWS FOR SUFFICIENT PLAY IN THE HARNESSSES, CABLES AND FUEL LINES BEING ROUTED THROUGH THE RIGGING HOSE. THE RIGGING HOSE SHOULD HAVE LARGE SWEEPING BENDS DURING STEERING.
- 3) CHOOSE A PATH FOR THE HARNESSSES, CABLES AND FUEL LINES THAT WILL ALLOW THEM TO BE ROUTED AS STRAIGHT AS POSSIBLE TO AVOID SHARP BENDS.
- 4) THIS RIGGING THRU HULL WILL SWIVEL 12 DEGREES IN A 360 DEGREE PATTERN TO HELP WITH MISS ALIGNMENT.
- 5) TAPE TEMPLATE TO THE TRANSOM.
- 6) USE HOLE SAW FOR THE CENTER 3-3/8 HOLE.
- 7) DRILL (4) 1/8 AS SHOWN.

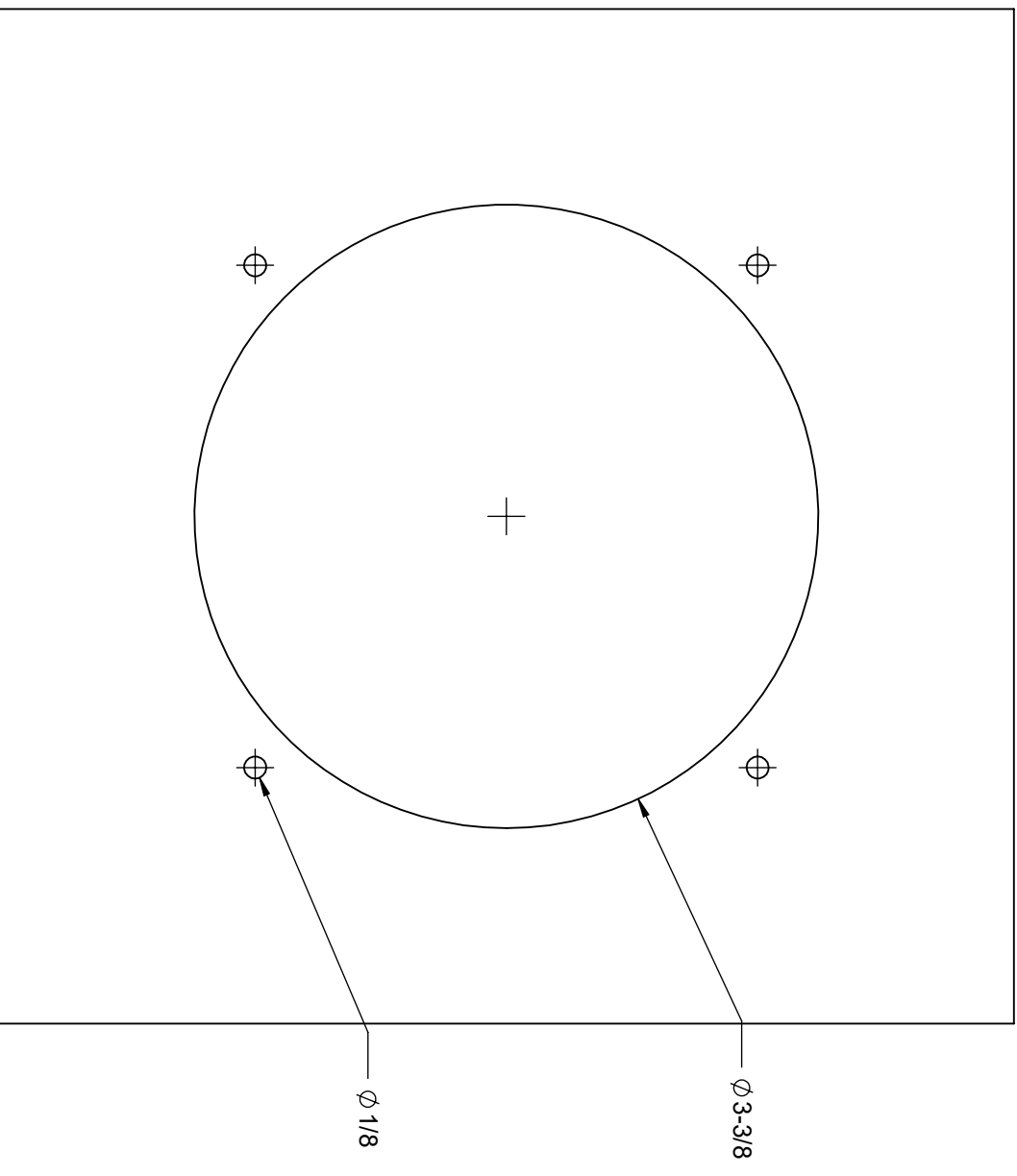

THIS DRAWING IS CONFIDENTIAL AND IS SUPPLIED ON EXPRESS CONDITION THAT IT SHALL NOT BE LENT, COPIED OR DISCLOSED TO ANY OTHER PERSON OR USED FOR ANY OTHER PURPOSE WITHOUT WRITTEN CONSENT OF HARDIN MARINE INC.. BREACH OF THIS CONTRACT WILL HOLD AND IT'S PRINCIPALS LIABLE FOR LOSS AND DAMAGES.



SWIVEL RIGGING HOSE KIT

755-1000,755-1001, 755-1002
& 755-1003

Components Contained in Kit

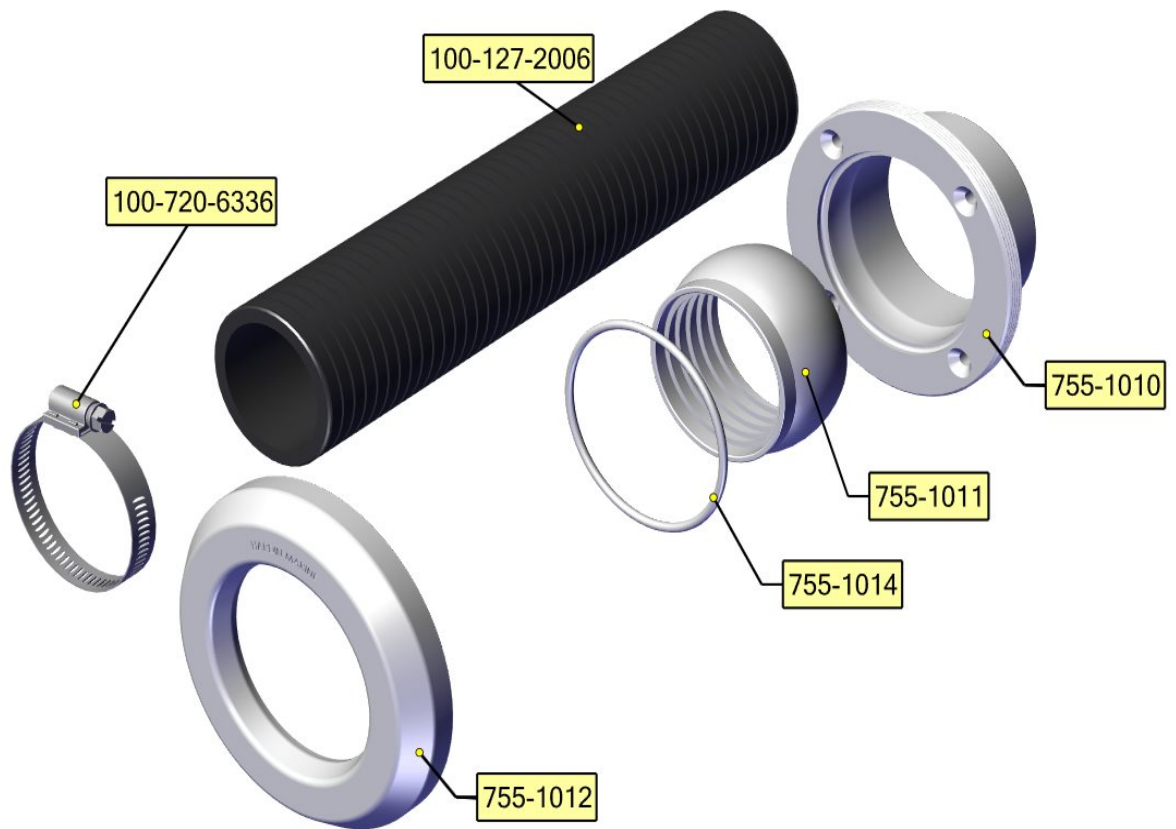

Both 100-720-6336 clamp & 100-127-2006 hose only comes in 755-1002 & 755-1003 hose kits.



SWIVEL RIGGING HOSE KIT

755-1000, 755-1001, 755-1002
& 755-1003

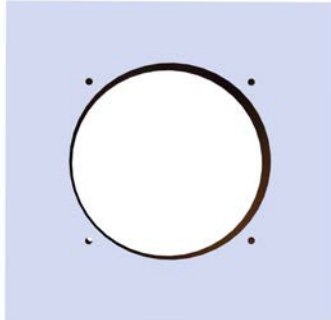

Step 1

- Use previous page template to position drill the required mounting hose for the base.

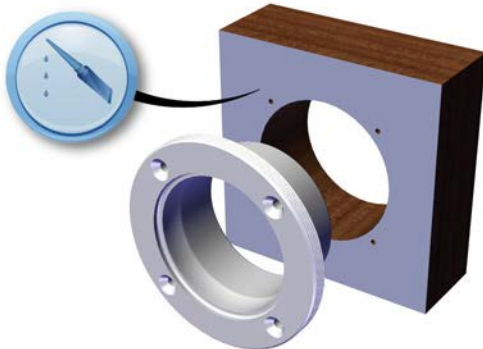

Step 2

- Use 5200 silicone between base and transom.
- Mount to transom using #10 screws, not supplied in the kit.

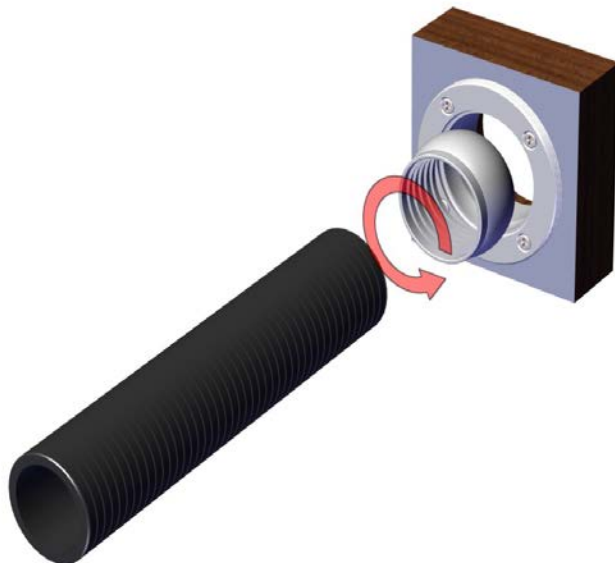

Step 3

- Turning counter clockwise, install hose into the swivel.
- Install swivel and hose in the base.



SWIVEL RIGGING HOSE KIT

755-1000, 755-1001, 755-1002
& 755-1003

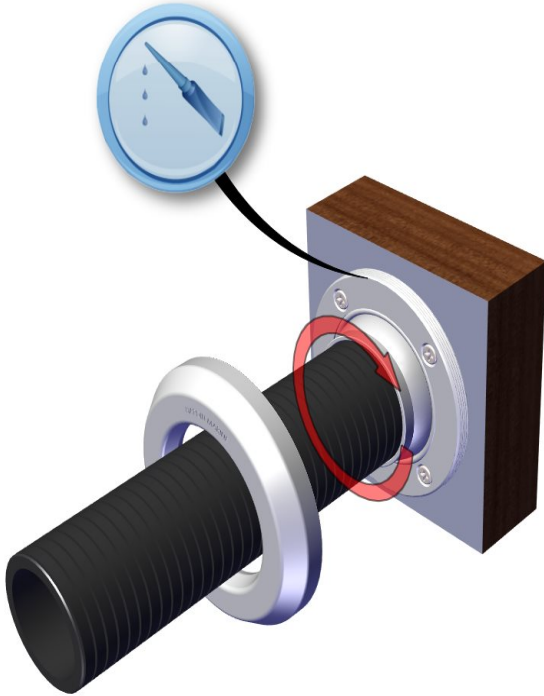

Step 4

- Install o-ring into the base groove.
- Apply 5200 to the outside threads on the base.
- Screw cover onto the base. Tighten till the swivel has a slight drag and the swivel rotates freely.